

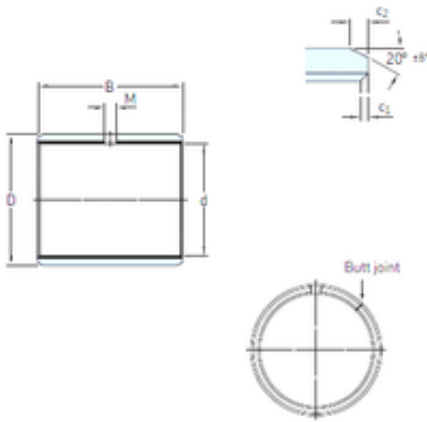

NTN-SNR BEARING RULMENTI S.R.L.



16 mm x 18 mm x 15 mm skf PCM 161815 E
Plain bearings, Bushings

Bearing No. PCM 161815 E

PCM 161815 E Bearing 2D drawings and 3D CAD models

Size	16x18x15 mm
Bore Diameter	16 mm
Outer Diameter	18 mm
Width	15 mm
d	16 mm
D	18 mm
B	15 mm
c1 min	0,1 mm
c2 min	0,2 mm
M	– mm
Weight	0,0059 Kg
Basic dynamic load rating (C)	19,3 kN
c ₁ min.	0.1 mm
c ₁ max.	0.6 mm
c ₂ min.	0.2 mm
c ₂ max.	1 mm
± 8	20 °
Tolerance shaft	f7
Tolerance housing	H7
Basic dynamic load rating - radial direction C	19.3 kN
Basic static load rating - radial direction C ₀	60 kN
Specific dynamic load factor K	80 N/mm ²
Specific static load factor K ₀	250 N/mm ²



NTN-SNR BEARING RULMENTI S.R.L.

Factor depending on material and bearing type K_M	480
Permissible sliding velocity v min.	0 m/s
Permissible sliding velocity v max.	2 m/s
Coefficient of friction μ min.	0.03
Coefficient of friction μ max.	0.25
Mass bushing	0.0059 kg